

# PRODUCT INFORMATION MODEL 2304 APERO

© 2023 KURT BEIER & KATI QUINGER



Aperro workmanship with pleating.



Aperro workmanship "Special Cover"

**APERRO:** DINING LUXURY. DESIGN, COMFORT AND OPULENCE. SWIVEL SEATS WITH THE ARMREST COMFORT OF AN ARMCHAIR IN COMBINATION WITH THE DECORATIVE DINING SOFA, AS WELL AS TABLES MADE OF SOLID REAL WOOD AND GRACEFUL STEEL DESIGN. AVAILABLE IN 2 FINISHES, ARMCHAIR AND BENCH WITH ELEGANT PLEATING OR AS "SPECIAL COVER" WITHOUT PLEATING WITH FUNCTIONAL BENCH. MATERIAL, FUNCTION AND CRAFTSMANSHIP FROM ONE MOULD. CHARMINGLY SEDUCTIVE TEXTILES OF THE BEST QUALITY, OR A SELECTION OF OUR LEATHER COVERS STAND FOR THE SPECIAL BULLFROG COUTURE. SIMPLY OWN, FEEL GOOD AND ENJOY. A TRULY CREATIVE PRODUCT FROM BULLFROG. UNIQUE PIECE PRODUCTION.

## Option with elegant pleating:

Processing option of main seam / decorative seam with type 146 / type B200 / type B220

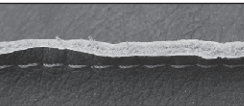
	Plain seam	Raw edged
		
Fabric	x	
Leather	x	
Fake fur	x	

**ATTENTION! THE FOLLOWING LEATHERS CANNOT BE SELECTED FOR MODEL 2304 APERO:**

2180 NAVAJO / 2323 CASHMERE / 2399 RHINO / 2625 CRAZY NECK

It is possible to order main seam or decorative seam either tone in tone like the colours of cover or in the contrasting colours white, nature, grey, rust and black. On request special colours possible.

\*Zipper piping: optionally in the colours black, red, nature or light grey.



Comfortable armchair with pleating and 360° rotation function



Bench seat with pleating, without armrest

## Option „Special Cover“ without pleating with functional bench:

Processing option of main seam / decorative seam with type 146SC / type B200FL / type B220FR

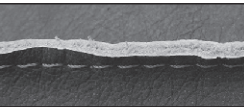
	Plain seam	Raw edged
		
Fabric	x	
Leather		x
Fake fur	x	

It is possible to order main seam or decorative seam either tone in tone like the colours of cover or in the contrasting colours white, nature, grey, rust and black. On request special colours possible.

\*Zipper piping: optionally in the colours black, red, nature or light grey.













Comfortable armchair with 360° rotation function  
Special Cover



Bench with functional armrest...



...for comfortable relaxation

Wood, standard surfaces:											
	Natural spruce brushed	Spruce brushed, grey stained (Vintage-Style)	Common ash natural	Ash black stained	Ash black brown	Wild oak	Beam oak	Old oak	Steamed oak	Smoked oak	American walnut
	(light puttied)		(brown puttied)			(dark puttied)	(not puttied)	(not puttied)	(dark puttied)	(dark puttied)	(dark puttied)
Price group	PG1	PG1	PG2	PG2	PG2	PG3	PG4	PG4	PG4	PG5	PG6
											
Untreated	∅	∅	*	∅	∅	*	∅	✓	✓	✓	*
Oiled	∅	∅	*	∅	∅	✓	∅	*	*	*	✓
Lacquered	∅	∅	✓	∅	✓	*	✓	*	*	*	*

Untreated wood gets its unique character due to the naturals. Colour or structure variations from the samples shown are standard and have to be accepted. The wood will get a desired patina overtime with daily use, which emphasizes the character of the wood. For further care please notice the general wood information. Puttied areas may have a different colour appearance depending on the surface. For example, dark putty can look lighter on untreated wood.

\* = Available on request against processing surcharge  
 ✓ = Bullfrog recommendation and standard surface  
 ∅ = These variants are not available

<b>Turntable, table TR180RH:</b>	<p>Our natural stone table top, Jura grey, finely polished surface, is a limestone from the Altmühltal near Eichstätt. Its characteristics are the inclusions of fossilized shells and its homogeneous greyish structure. The table tops are treated with a food-safe impregnation at the factory. For daily care, the natural stone can be wiped with a microfiber cloth and a non-acidic, preferably PH neutral soap.</p> <p>Attention! Natural stone is sensitive to acids! Fruit acids, vinegar, lime residues or even tannic acids in red wine, for example, can penetrate the stone and attack the surface.</p>
Natural stone plate: Jura grey	
Sanded & impregnated	
	
✓	

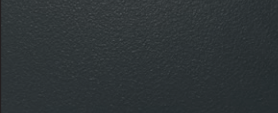
<b>Turntable, table TR150RH/ additional turntable TR70:</b>
Metal, matt black fine structure powder-coated
<b>black</b>

✓

**Lower frames:** round steel, powder-coated fine structure in black matt

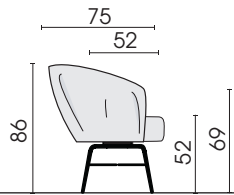

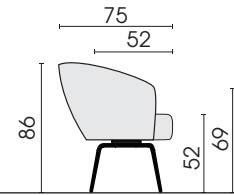

Side view, armchair



Side view, armchair

Pleated armchair

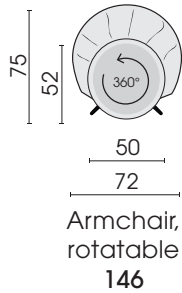

Armchair,  
rotatable  
146

Armchair

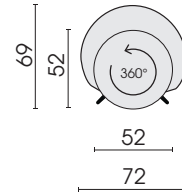

Armchair,  
rotatable,  
special cover  
146SC

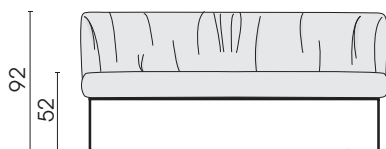

Front view type B200

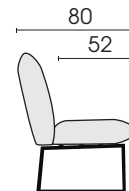

Side view

Pleated benches

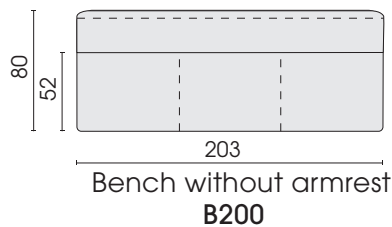

Bench without armrest  
B200

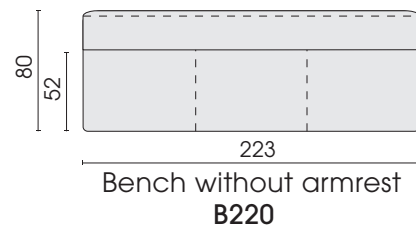

Bench without armrest  
B220

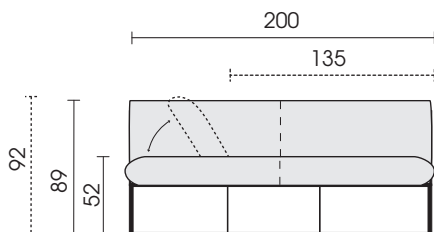

Front view type B200FL



Seitenansicht

Functional benches

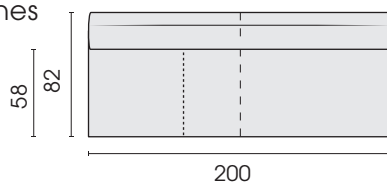

Functional bench  
armrest, left  
B200FL

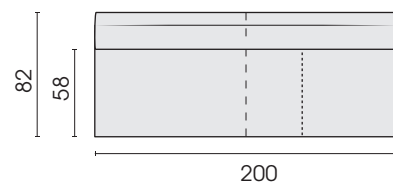

Functional bench  
armrest, right  
B200FR

Each piece of furniture is handmade and unique. Deviations to the listed measurements may be caused by:  
1. different upholstery materials (fabric, leather), 2. processing of ticking mats, 3. the pressure to combine individual parts, etc.  
The seat comfort of a sofa type with larger seat depth usually differs from one with lower depth.

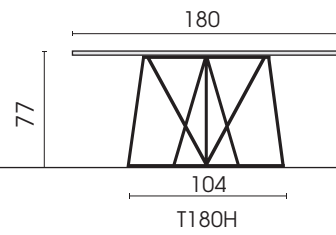
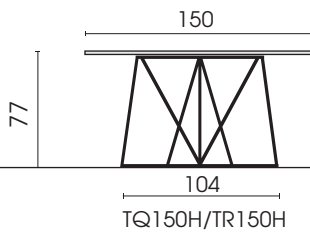

Tables

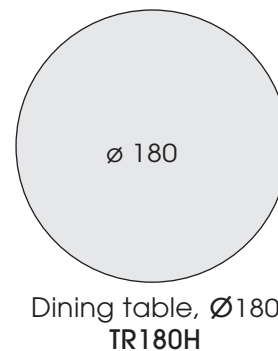
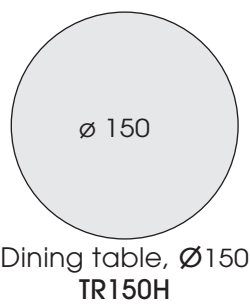
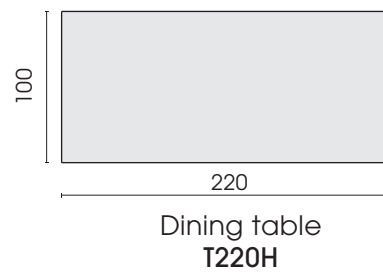
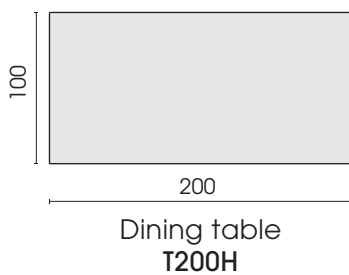
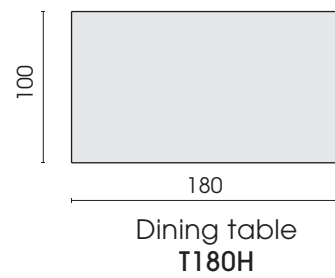
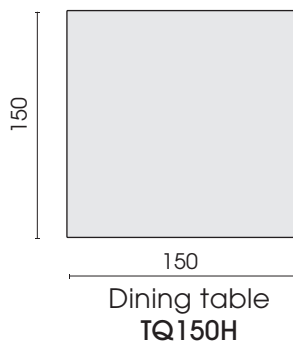

Table, including insertable turntable (flush with the adjacent areas):

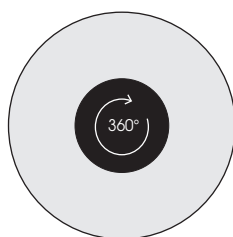

**Insertable turntable:**  
metal plate, powder-coated  
fine structure in black matt

Dining table, Ø150  
with inserted turntable, Ø62  
**TR150RH**

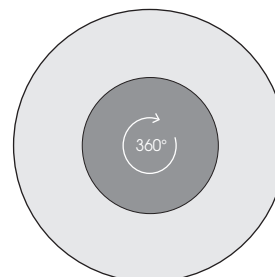

**Insertable turntable:**  
Natural stone plate,  
Jura, grey

Dining table, Ø180  
with inserted turntable, Ø90  
**TR180RH**

Each piece of furniture is handmade and unique. Deviations to the listed measurements may be caused by:  
1. different upholstery materials (fabric, leather), 2. processing of ticking mats, 3. the pressure to combine individual parts, etc.  
The seat comfort of a sofa type with larger seat depth usually differs from one with lower depth.

Additional turntable, compatible with the following dining tables:

- TR150H
- TQ150H
- T180H
- T200H
- T220H



Turntable  
 ø 62 cm  
 H=2,5 cm  
**TR70**

Additional turntable: metal plate, matt black fine structure powder-coated

Combinations

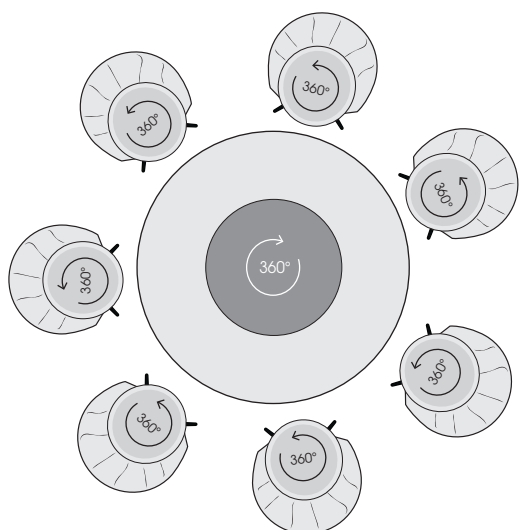

- 7 x type 146  
 - Type TR180RH

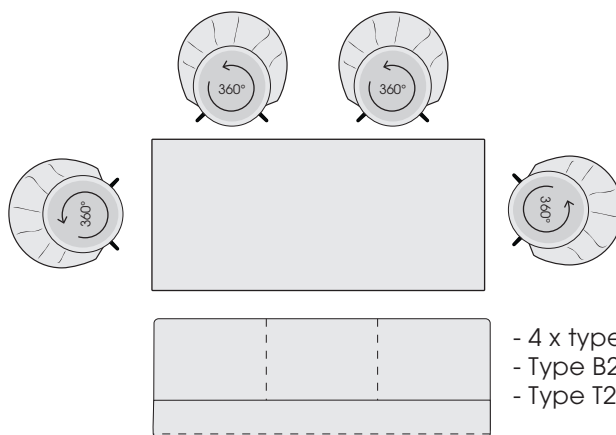

- 4 x type 146  
 - Type B220  
 - Type T220H

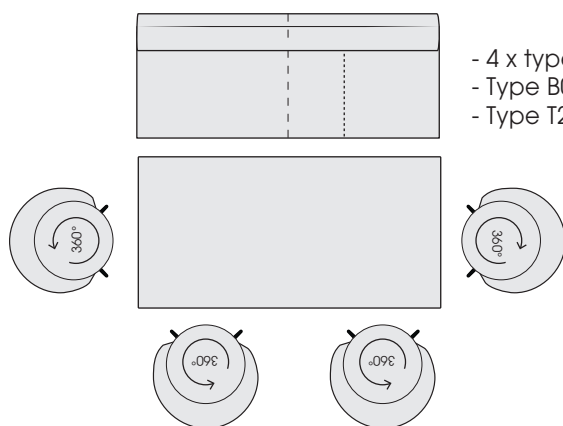

- 4 x type 146SC  
 - Type B00FR  
 - Type T200H

Each piece of furniture is handmade and unique. Deviations to the listed measurements may be caused by:  
 1. different upholstery materials (fabric, leather), 2. processing of ticking mats, 3. the pressure to combine individual parts, etc.  
 The seat comfort of a sofa type with larger seat depth usually differs from one with lower depth.