

# PRODUCT INFORMATION MODEL 1517 TWISTER

© 2017 KURT BEIER & KATI QUINGER



With or without armrest available



360° rotary function



Rocking function

**TWISTER:** PASSION FOR STYLE. SWIVEL AND ROCKING ARMCHAIR WITH ELEGANT MATERIAL MIX AND 360° ROTATING FUNCTION. LIGHT, FINE ARMRESTS, OPTIONALLY MADE OF WOOD, METAL OR COVERED. ON REQUEST WITH MATCHING STOOL. METAL BASE PLATE, BLACK MATT, FINE STRUCTURE POWDER-COATED. WOOD TYPES, COVERS (FABRIC/LEATHER) AND SEAM TYPE SELECTABLE. UNIQUE PIECE PRODUCTION.

**Metal armrest (type 145/145SC):** metal, metal, matt black fine structure powder-coated  
**Wood armrest (type 145H/145HSC):** Solid wood versions selectable (see table)  
**Covered armrest (typ 145C/145CSC):** Sand  
**Turning and swing system, chair:** metal, matt black fine structure powder-coated  
**Attention! maximum load:** up to 110 kg  
**Feet, stool (type 550/550SC):** plastic glides: 3,5 cm



**Armrest versions:**



Wood armrest







Metal armrest

Covered armrest

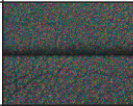
**Attention!**  
 With "SPECIAL COVER" processing  
 there are no dividing seams at  
 seat and back.

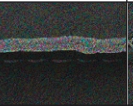

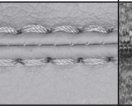
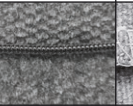
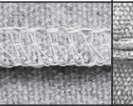
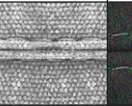
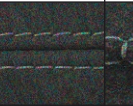
## Processing options of main seam / decorative seam (type 145/140/145H/145C/550)

	Plain seam	Lap seam	Raw edged	Moccasin seam extra charge	Twin seam extra charge	KR* (zipper piping) extra charge	Overcast seam extra charge	Piping	Two needle seam	Square seam extra charge
										
Fabric								x		
Leather			x							
Faux fur	x									

It is possible to order main seam or decorative seam either tone in tone like the colours of cover or in the contrasting colours white, nature, grey, rust and black. On request special colours possible.

\*Zipper piping: optionally in the colours black, red, nature or light grey.

## Processing options of seam with „SPECIAL COVER“

(type 145SC/140SC/145HSC/145CSC/550SC)

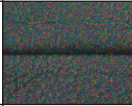
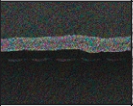
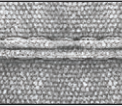
	Plain seam	Raw edged	Piping
			
Pattern fabrics / Cord			x
Thick leather 2625 CRAZY NECK		x	

It is possible to order main seam or decorative seam either tone in tone like the colours of cover or in the contrasting colours white, nature, grey, rust and black. On request special colours possible.

## Wood, standard surfaces:

	Natural spruce brushed	Spruce brushed, grey stained (Vintage-Style)	Common ash natural	Ash black stained	Ash black brown	Wild oak	Beam oak	Old oak	Steamed oak	Smoked oak	American walnut
	(light puttied)		(brown puttied)			(dark puttied)	(not puttied)	(not puttied)	(dark puttied)	(dark puttied)	(dark puttied)
Price group	PG1	PG1	PG2	PG2	PG2	PG3	PG4	PG4	PG4	PG5	PG6
Untreated											
Oiled	∅	∅	*	∅	∅	∅	∅	∅	∅	∅	∅
Lacquered	∅	∅	∅	∅	∅	∅	∅	∅	∅	∅	∅

Untreated wood gets its unique character due to the naturalness. Colour or structure variations from the samples shown are standard and have to be accepted. The wood will get a desired patina overtime with daily use, which emphasizes the character of the wood. For further care please notice the general wood information. Puttied areas may have a different colour appearance depending on the surface. For example, dark putty can look lighter on untreated wood.

\* = Available on request against processing surcharge

✓ = Bullfrog recommendation and standard surface

∅ = These variants are not available



Processing options of main seam (type 145/140/145H/145C) with fabric, leather and faux fur

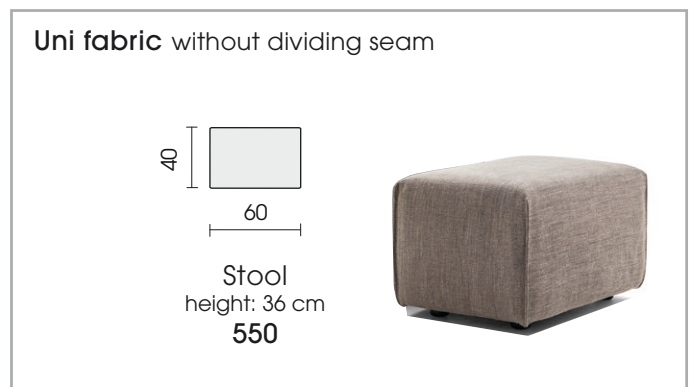
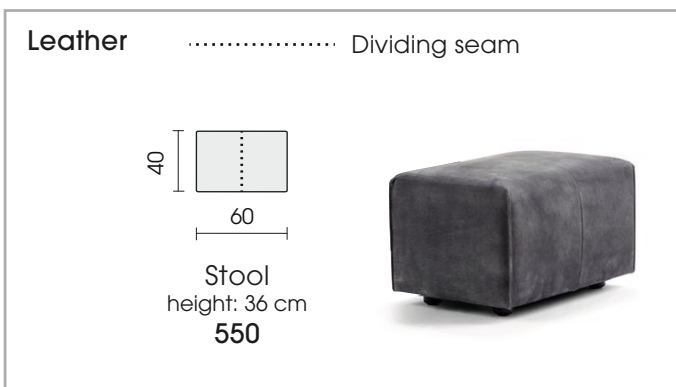
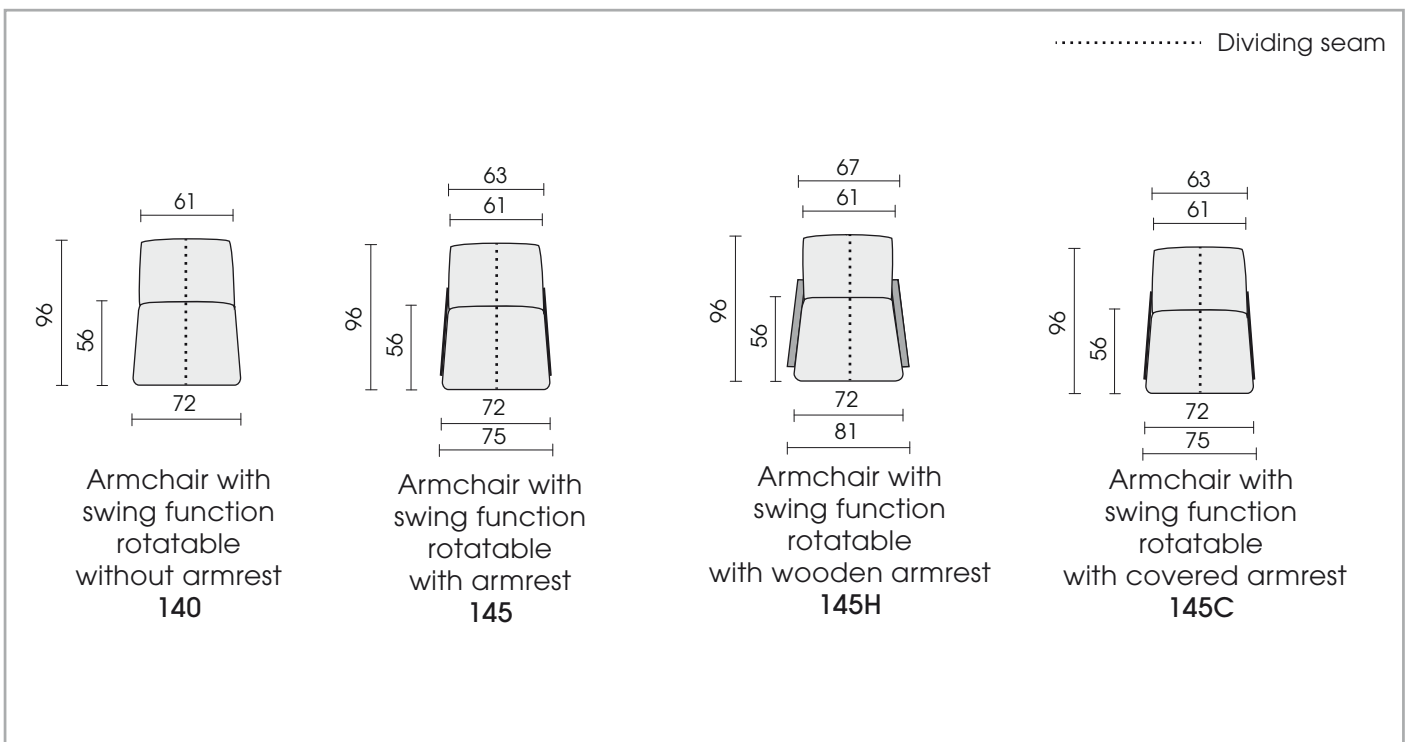
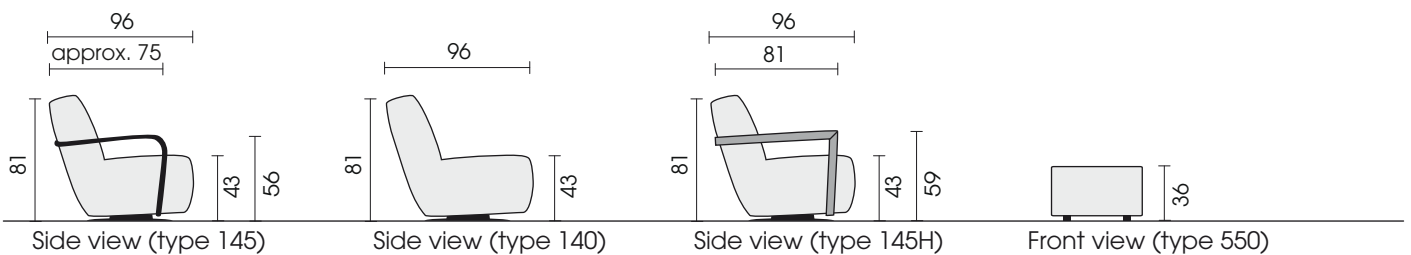

Each piece of furniture is handmade and unique. Deviations to the listed measurements may be caused by:  
 1. different upholstery materials (fabric, leather), 2. processing of ticking mats, 3. the pressure to combine individual parts, etc.  
 The seat comfort of a sofa type with larger seat depth usually differs from one with lower depth.

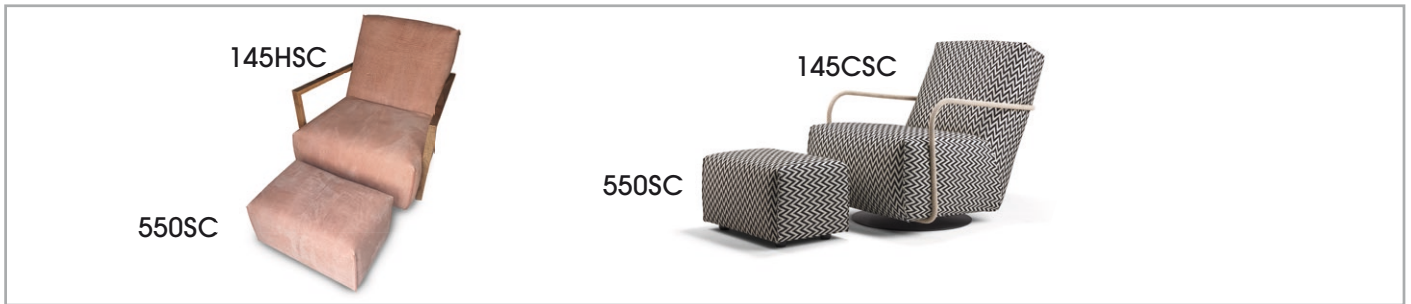

Processing options of seam „SPECIAL COVER“ (type 145SC/140SC/145HSC/145CSC/550SC) with pattern fabrics, cord and thick leather

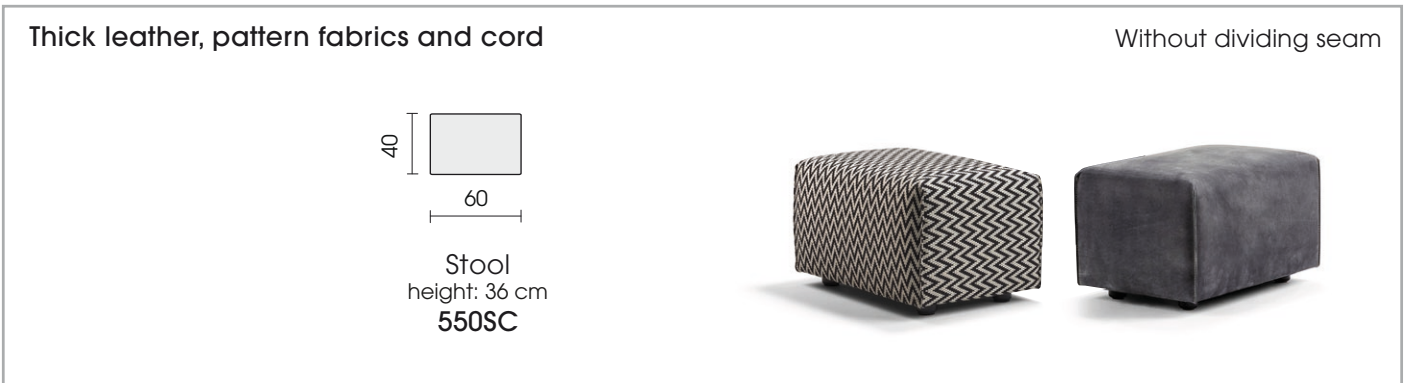
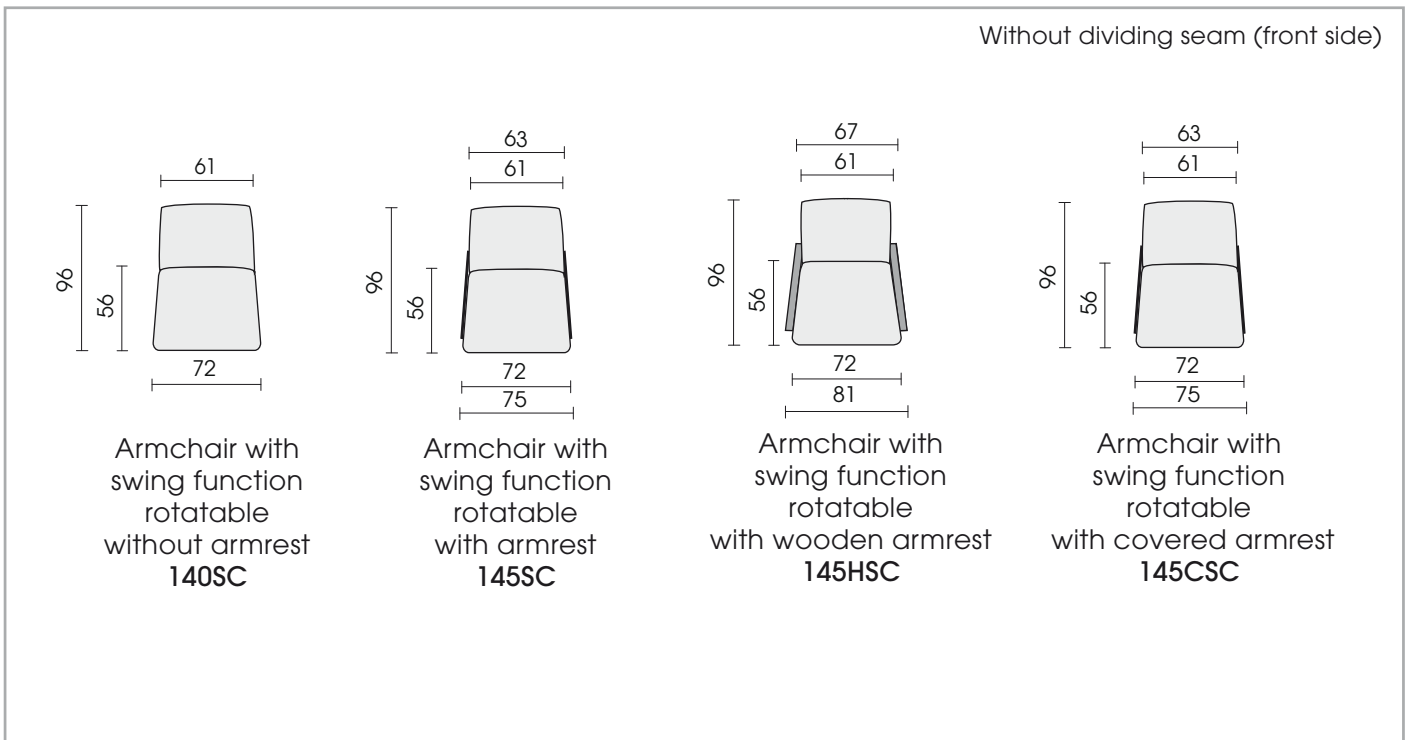
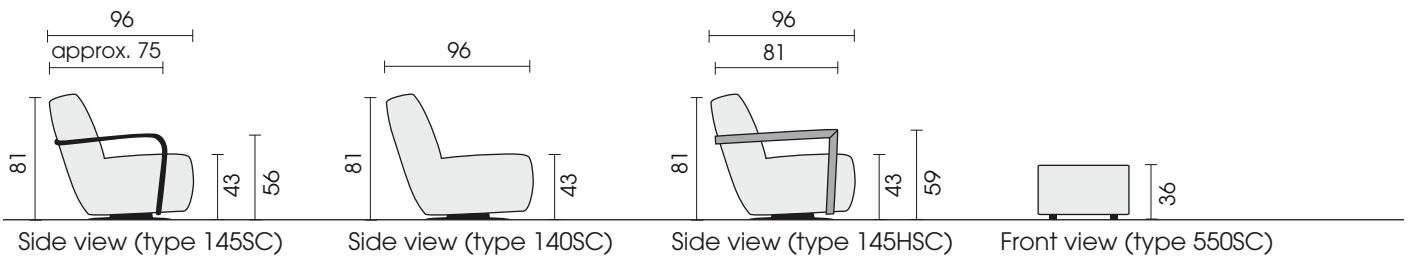

Each piece of furniture is handmade and unique. Deviations to the listed measurements may be caused by:  
1. different upholstery materials (fabric, leather), 2. processing of ticking mats, 3. the pressure to combine individual parts, etc.  
The seat comfort of a sofa type with larger seat depth usually differs from one with lower depth.