

# PRODUCT INFORMATION MODEL 0917 ZAZA

© 2017 KURT BEIER & KATI QUINGER



Removable armrest or stool



Sofa with relax- and sleeping position



Continuously motorised adjustment  
up to reclining position







## ZAZA: MAGIC MOMENTS

SIT, RELAX, SLEEP. A VERSATILE, MODULAR RANGE WITH SOFT, FEMININE LINES. UPHOLSTERY, ARM AND BACK ELEMENTS SOFTLY ROUNDED ON A SEEMINGLY FLOATING PLATFORM. SOFA ARMRESTS MANUALLY ADJUSTABLE, THE UPHOLSTERED ELEMENTS WITH MOTORISED FUNCTIONS CAN BE MOVED INTO HORIZONTAL POSITION. VARIOUS COVERS (FABRIC/LEATHER) AND SEAM FINISHINGS AVAILABLE. UNIQUE PIECE PRODUCTION.

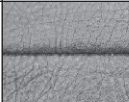
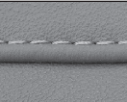
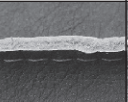

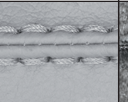
**Feet:** angle steel feet, matt black fine structure powder-coated.  
**Height, optionally:** 10 cm/14 cm / **Floor distance:** approx. 10 cm or 14 cm

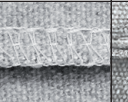
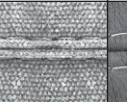
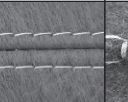
### Processing options of main seam / decorative seam

	Plain seam	Lap seam	Raw edged	Moccasin seam extra charge	Twin seam extra charge	KR* (zipper piping) extra charge	Overcast seam extra charge	Piping	Two needle seam	Square seam extra charge
										
Fabric								x		
Leather			x							
Fur										
Fake fur	x									

It is possible to order main seam or decorative seam either tone in tone like the colours of cover or in the contrasting colours white, nature, grey, rust and black. On request special colours possible.

\*Zipper piping: optionally in the colours black, red, nature or light grey.

Attention! Fabric and leather: the plateau is always processed with plain seam.

### Further combination examples



### Standard version for motorised drive:

- wireless remote control
- power supply

Optionally with battery for an extra charge.

Feet:



Angular steel feet, powder-coated fine structure in black matt

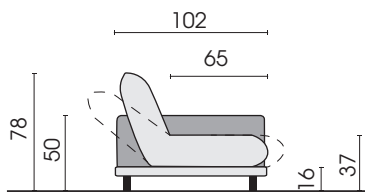

Side view (feet height: 10 cm)

▷ = Connector side

Single elements with motorised seat adjustment

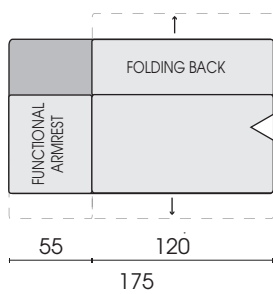

Sofa 2-seat  
Functional armrest left,  
with motorised seat adjustment  
**26M**

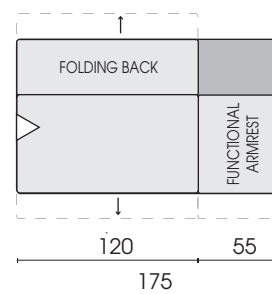

Sofa 2-seat  
Functional armrest right,  
with motorised seat adjustment  
**25M**

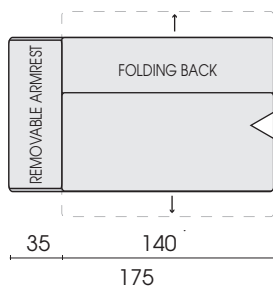

Sofa 2,5-seat  
removable armrest left,  
with motorised seat adjustment  
**58M**

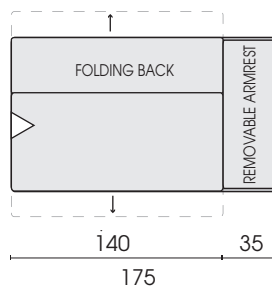

Sofa 2,5-seat  
removable armrest right,  
with motorised seat adjustment  
**57M**

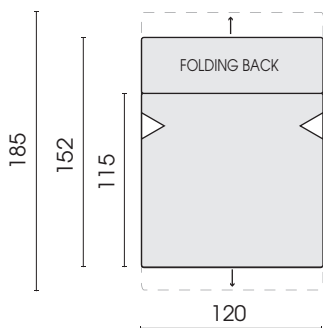

Functional lounger, wide,  
with motorised  
seat adjustment  
**440F**

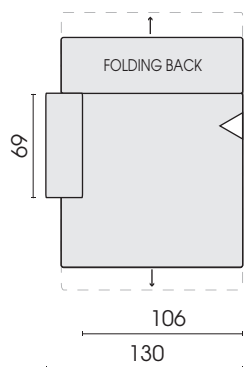

Functional lounger, wide,  
armrest left,  
with motorised  
seat adjustment  
**442F**

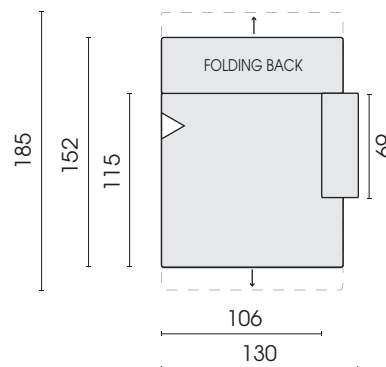

Functional lounger, wide,  
armrest right,  
with motorised  
seat adjustment  
**441F**

Each piece of furniture is handmade and unique. Deviations to the listed measurements may be caused by:  
1. different upholstery materials (fabric, leather), 2. processing of ticking mats, 3. the pressure to combine individual parts, etc.  
The seat comfort of a sofa type with larger seat depth usually differs from one with lower depth.

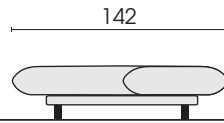
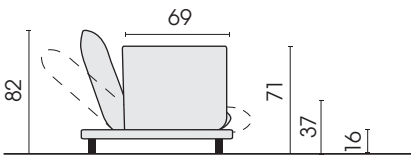

Side view type 300 (feet height: 10 cm)

Sleep position type 300 (feet height: 10 cm)



▷ = Connector side

Single element with sleep function

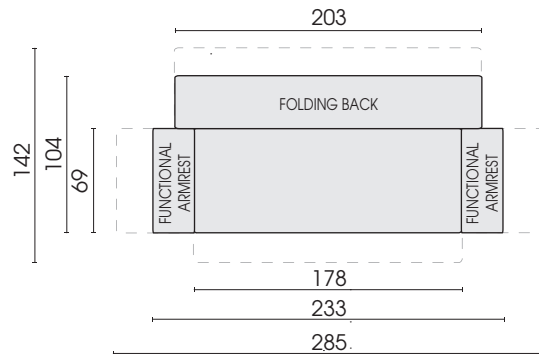

Sofa 3-seat, 2 armrests, with sleep function  
**300MF**

Cushions with decorative seams are either tone in tone or with contrasting colours possible.

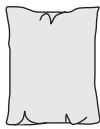

**Funki S**  
Functional cushion  
(tapered cushion)  
(Fabric: plain seam)  
(Leather: raw edged)  
62x78  
**582**

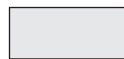

**Cushion**  
(tapered cushion)  
(plain seam)  
78 x 34  
**566**



**Cushion**  
(tapered cushion)  
(leather)  
(raw edged)  
78 x 34  
**998**



**Cushion**  
(tapered cushion)  
(Fabric: decorative  
overcast seam)  
78 x 34  
**999**

Single elements (removable)

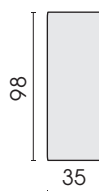

**Stool / armrest**  
removable  
H = 33 cm  
**632**

Slide table, model 1117, solid wood  
(available in different wood types)

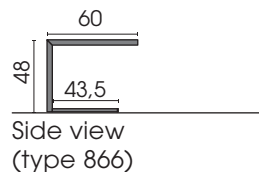

Side view  
(type 866)

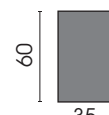

**Table**  
to push  
**866**

Each piece of furniture is handmade and unique. Deviations to the listed measurements may be caused by:  
1. different upholstery materials (fabric, leather), 2. processing of ticking mats, 3. the pressure to combine individual parts, etc.  
The seat comfort of a sofa type with larger seat depth usually differs from one with lower depth.

Combinations:

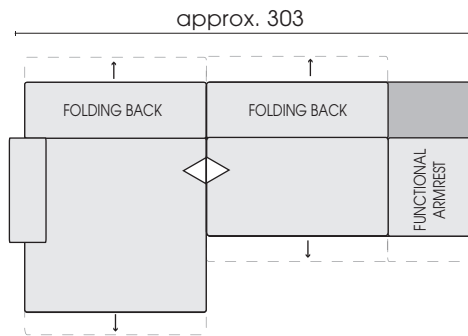

**Combination 2L**  
(442F + 25M)

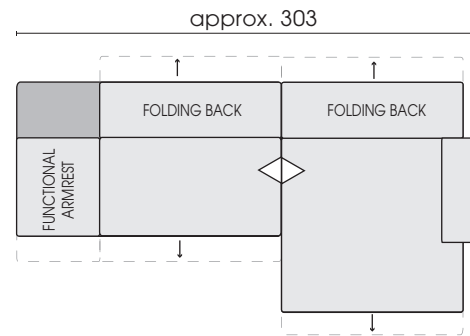

**Combination 2R**  
(26M + 441F)

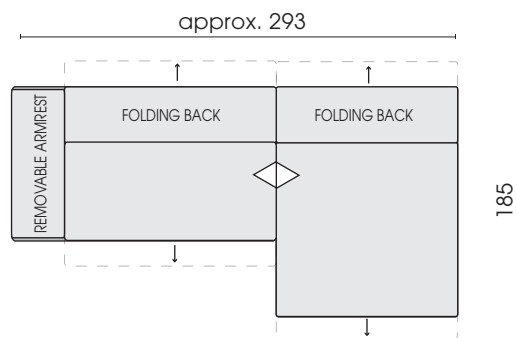

- Type 58M
- Type 440F
- Type 866

Each piece of furniture is handmade and unique. Deviations to the listed measurements may be caused by:  
 1. different upholstery materials (fabric, leather), 2. processing of ticking mats, 3. the pressure to combine individual parts, etc.  
 The seat comfort of a sofa type with larger seat depth usually differs from one with lower depth.